

36" x 60" ELMIRA LEFT THRU CAB

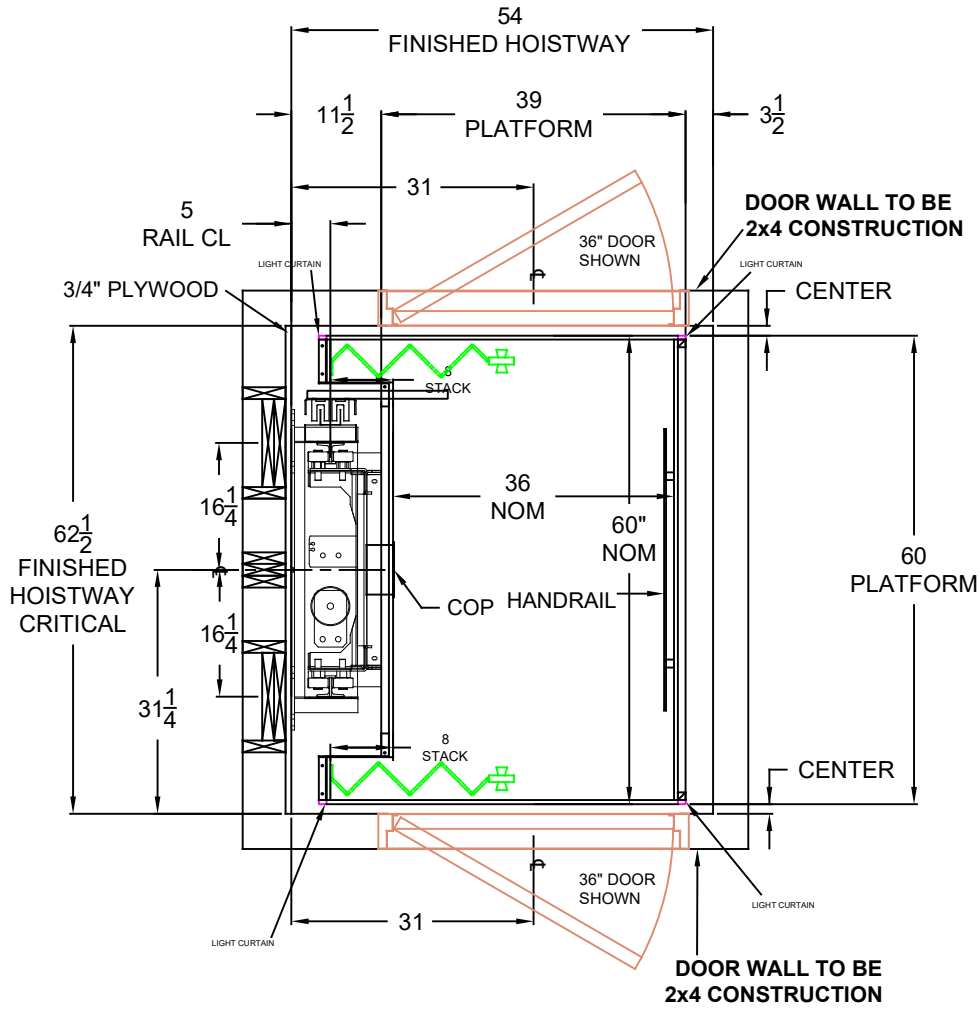

DRAWING NOTES

CAMBRIDGE ELEVATING'S RECOMMENDED MINIMUM HOISTWAY REQUIREMENTS LAYOUT DRAWING FOR HOISTWAY CONSTRUCTION ONLY FINAL CAB LAYOUT MAY VARY ALTHOUGH THE ELEVATOR IS DESIGNED TO MEET CSA-B44/ ANSI A17.1. LOCAL CODES MAY VARY. DEALER IS RESPONSIBLE FOR COMPLYING WITH LOCAL CODES CAMBRIDGE ELEVATING INC. IS NOT RESPONSIBLE FOR THE STRUCTURAL DESIGN OF THE BUILDING AND ITS ABILITY TO SUPPORT THE ELEVATOR LOADS AND/OR REACTIONS CAMBRIDGE ELEVATING INC. RESERVES THE RIGHT TO ALTER EQUIPMENT & HOISTWAY REQUIREMENTS WITHOUT NOTICE

PRODUCTION APPROVALS

THIS DRAWING REFLECTS OUR INTERPRETATION OF THE INFORMATION THAT WAS PROVIDED ON THIS PRODUCT'S ORDER FORM AND EXACT ELEVATOR SITE MEASUREMENTS THIS INFORMATION IS YOUR RESPONSIBILITY AND IS THE BASIS FROM WHICH THE CUSTOM APPLICATION DESIGN IS DERIVED. PLEASE INDICATE YOUR REQUESTED ACTION BY CHECKING ONE OF THE BELOW BOXES AND SIGNING BELOW TO AUTHORIZE COMPLETION OF THIS ORDER.

- APPROVED WITH NO EXCEPTIONS. MANUFACTURE THIS ELEVATOR PER INFORMATION ON THIS DRAWING
- APPROVED AS NOTED. MAKE CHANGES AS NOTED BEFORE MANUFACTURE. NO RE-APPROVAL REQUIRED
- CHANGES AND REAPPROVAL REQUIRED

PRINT NAME:

DATE:

SIGNATURE:

CAMBRIDGE ELEVATING INC.

HOISTWAY PLAN VIEW	
DEALER NAME:	
JOB NAME:	
JOB NO:	ISSUE:
DATE:	DRAWN BY: